

MQ12 MALE 0° / MQ12 FEMALE 90° LED

PUR 4X0.34 black UL/CSA, drag ch 0.3m

Male straight – female 90°

MQ12 – MQ12, 4-pole

3× LED (PNP), (NPN) on request

Further cable lengths on request.

Plastic housings with good resistance against chemicals and oils.

The resistance to aggressive media should be individually tested for your application. Further details on request.

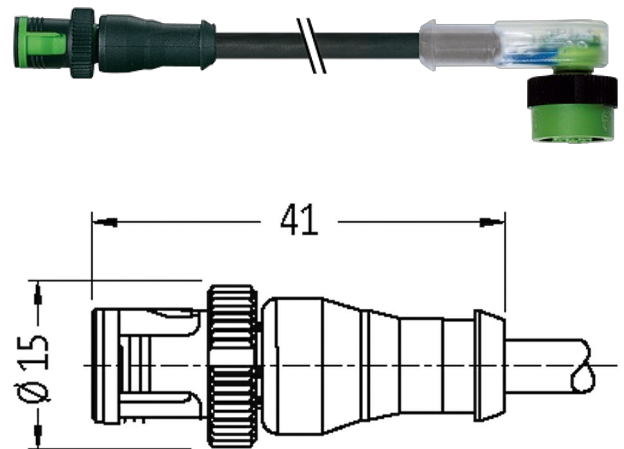
Link to Product**Illustration**

Product may differ from Image

Form

Form 40341

General data

Temperature range -25...+85 °C, depending on cable quality

Cables

No./diameter of wires	4 × 0.34 mm ²
Wire isolation	PP (br, wh, bl, bk)
C-track properties	10 Mio.
Material (jacket)	PUR (UL/CSA)
Outer Ø	4.5 mm ±5%
Bend radius (moving)	10× outer Ø
Temperature range (fixed)	-40...+80 °C
Temperature range (mobile)	-25...+80 °C
Cable identification	634
Cable Type	3 (PUR)
Approval (cable)	cURus (AWM-Style 20549/10493); CE conform
Cable weight [g/m]	36,30
Material (wire)	Cu wire, bare
Resistor (core)	max. 57 Ω/km (20 °C)
Single wire Ø (core)	0.1 mm
Construction (core)	42 × 0.1 mm (multi-strand wire class 6)

Diameter (core)	4 x 0.34 mm ²
AWG	similar to AWG 22
Material (wire isolation)	PP
Material property (wire isolation)	CFC-, halogen-, cadmium-, silicone- and lead-free
Shore hardness (wire isolation)	70 ±5 D
Wire-Ø incl. isolation	1.25 mm ±5%
Color/numbering of wires	br, bk, bl, wh
Stranding combination	4 wires twisted
Shield	no
Material (jacket)	PUR
Material property (jacket)	CFC-, halogen-, cadmium-, silicone- and lead-free, matt, low-adhesion, machine easy to process, abrasion-resistant, hydrolysis and microbial resistant
Shore hardness (jacket)	90 ±5 A
Outer-Ø (jacket)	4.5 mm ±5%
Color (jacket)	black
chemical resistance	good resistance to oil, gasoline and chemicals (EN 60811-404)
thermal resistance	flame retardant UL 1581 VW1 / CSA FT1 / IEC 60332-1, IEC 60332-2-2
Nominal voltage	300 V AC
Test voltage	2500 V AC
Current load capacity	to DIN VDE 0298-4
Temperature range (fixed)	-40...+80 °C, (+90 °C at max. 10 000 operating hours)
Temperature range (mobile)	-25...+80 °C, (+90 °C at max. 10 000 operating hours)
Bend radius (fixed)	5 x outer Ø
Bend radius (moving)	10 x outer Ø
No. of bending cycles (C-track)	max. 10 Mio. (25 °C)
Travel speed (C-track)	max. 3 m/s
Acceleration (C-track)	max. 10 m/s ²
Torsion stress	±180°/m
No. of torsion cycles	max. 2 Mio. (25 °C)
Torsion speed	35 cycles/min
Jacket Color	black

Technical Data

Operating voltage	24 V DC ±25%
Rated surge voltage	0.8 kV
Operating current per contact	max. 4 A
Locking of ports	Quick connection, 1/4 turn
Protection	IP65 and IP67 when plugged and screwed down (EN 60529)

Commercial data

country of origin	DE
customs tariff number	85444290
EAN	4048879105507
eClass	27279218
Packaging unit	1

Sketch

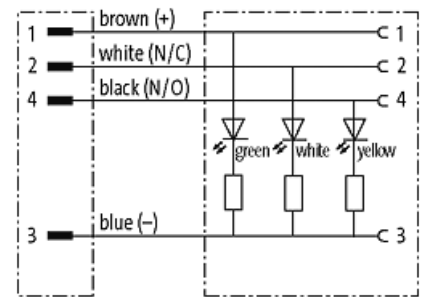

Male

Female

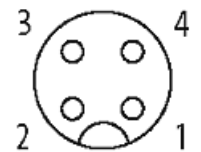
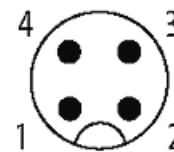

Product may differ from Image